









---



光盘



联机电缆



打印机

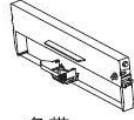

色带



电源线



说明书



保修卡



合格证



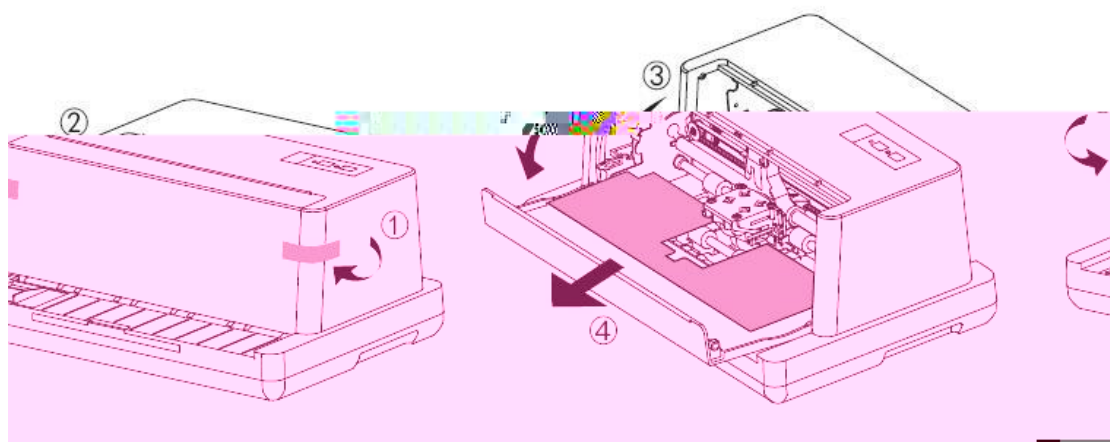

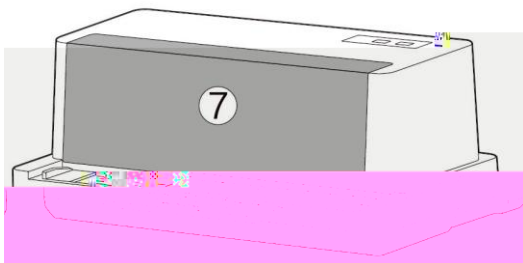
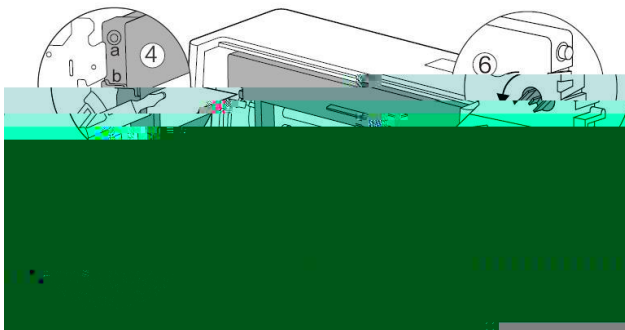
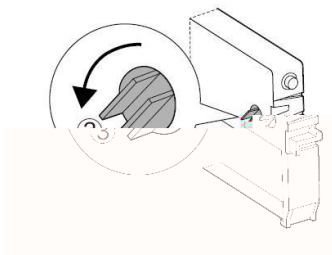
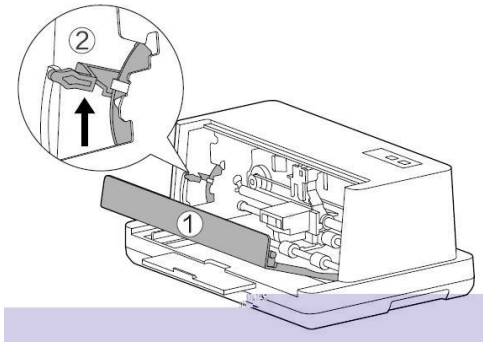



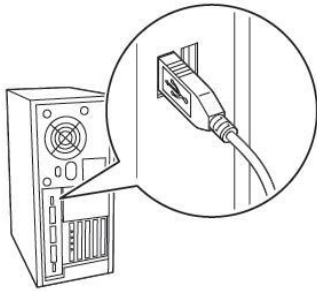
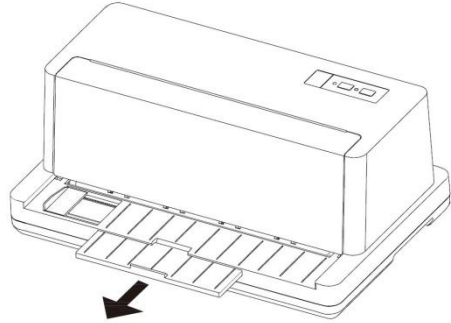

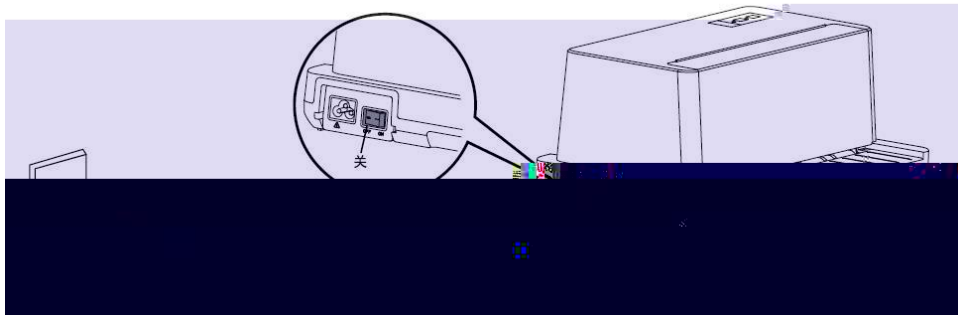

1. 5
- 2.

Windows XP / Vista / 7 / 8 / 10

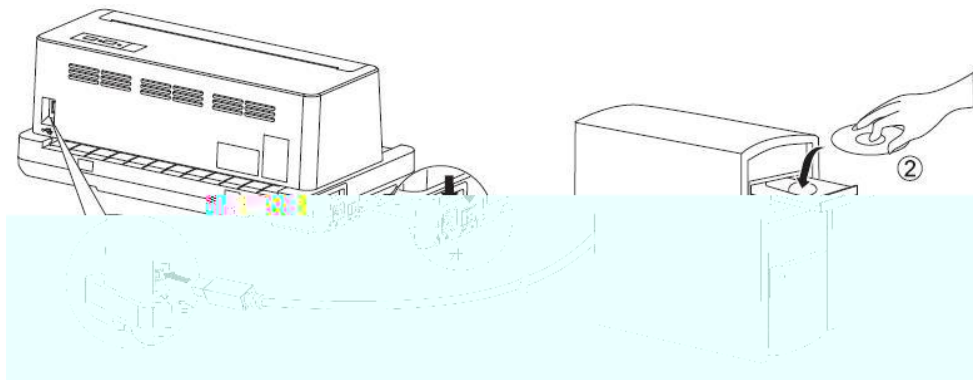

a. [DeliDriver.exe](#)

---

---

### 2.1.1

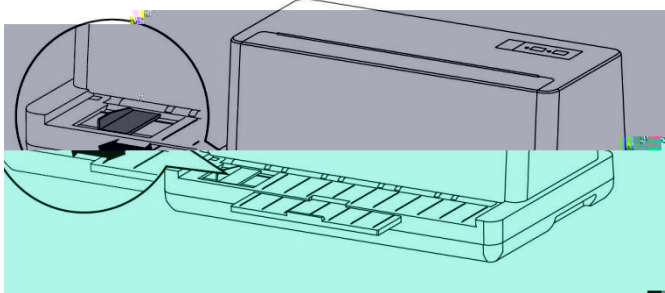
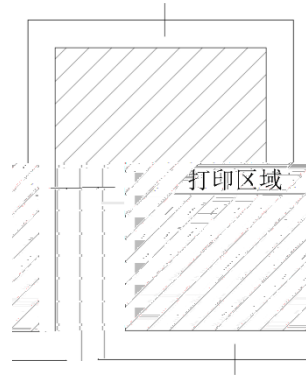

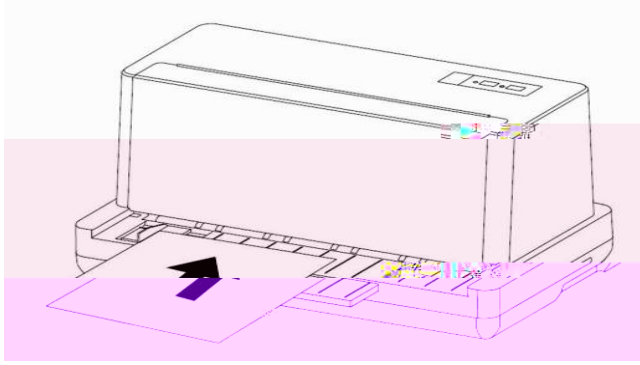
	2	+1
	3	+2
	4	+3
	5	+4
	6	+5





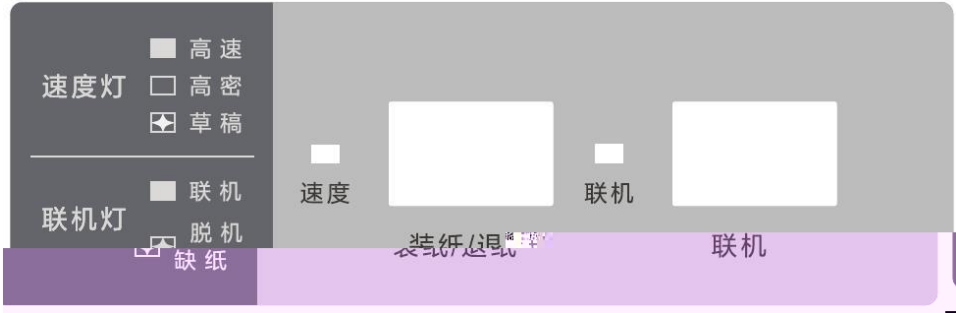

### 3.2.1



### 3.2.2





---

### 3.2.3

- 

- 

- 

- 

- 



---



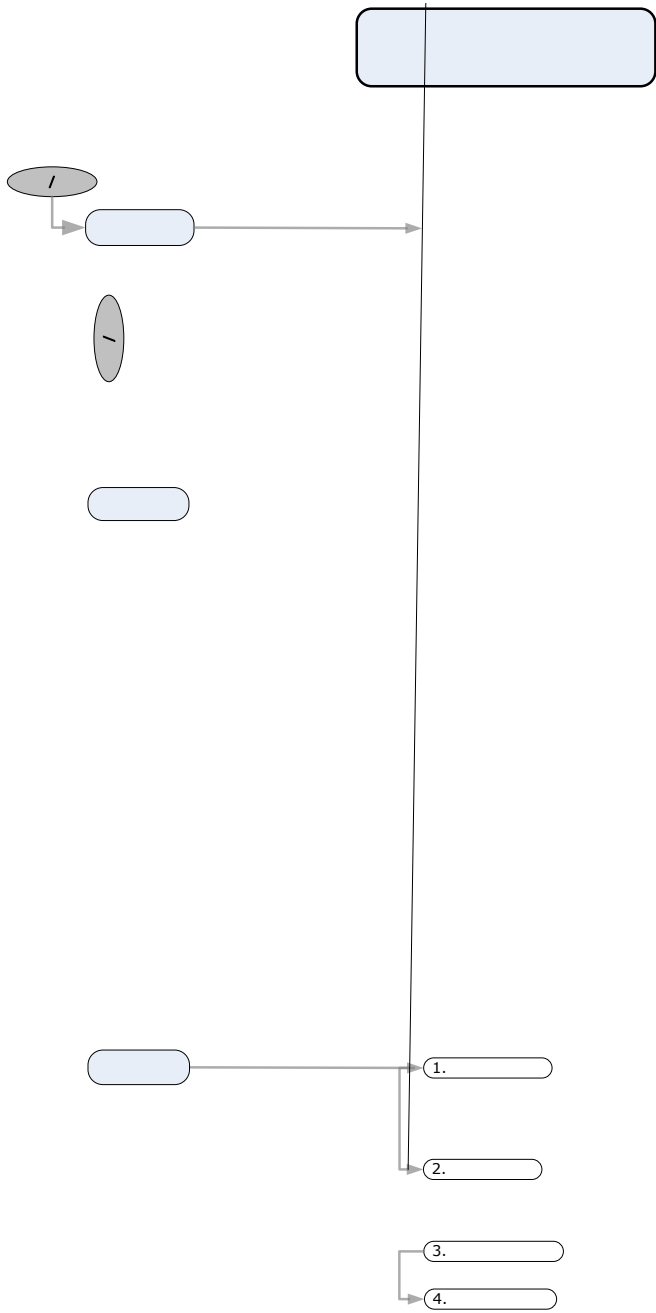

**N!**

---

### 4.2.1

---



①

②



---

**4.2.3**

---

**4.2.4**







---



--	--

---





---





- 
- 
-



# 1

## 产品中有害物质的名称及含量

部件名称	有害物质					
	铅(Pb)	汞(Hg)	镉(Cd)	六价铬 (Cr(VI))	多溴联苯 (PBB)	多溴二苯醚 (PBDE)
电线	○	○	○	○	○	○
印刷电路板	○	○	○	○	○	○
塑胶	○	○	○	○	○	○
轴, 金属轴	○	○	○	○	○	○
五金	○	○	○	○	○	○
其他金属	○	○	○	○	○	○

本表格依据SMT J1364的规定编制。

○：表示该有害物质在该部件所有均质材料中的含量均在GB/T 26572规定的限量要求以下。

×：表示该有害物质至少在该部件的某一均质材料中的含量超出GB/T 26572规定的限量要求。

注：本表格不适用于因全球供应链管控及军品特殊要求而豁免有害物质管控的部件。