

---

**DL-581P**

**DL-581PW**

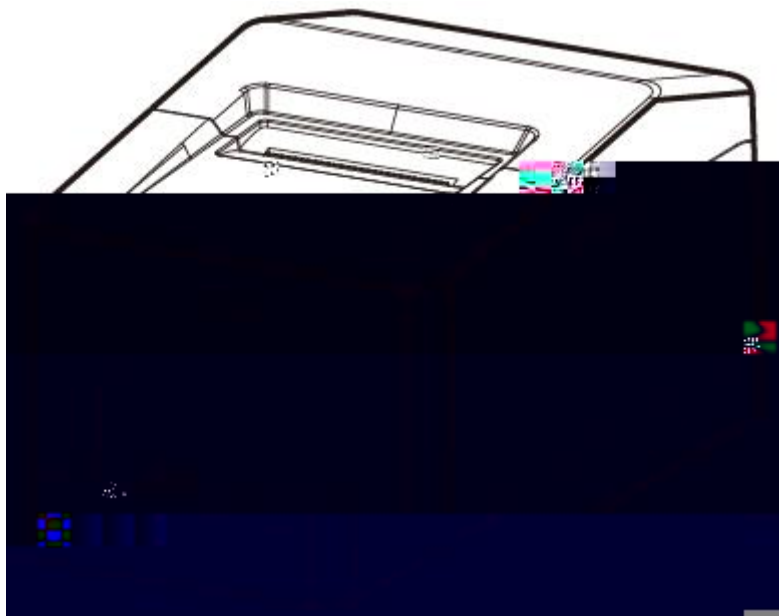

---

1.1

1.2

1.3

1.4

1.5

2.1

2.2

2.2.1

2.2.2

2.3

2.3.1

2.3.2

3.1

3.2

3.3

3.4

3.5

3.5.1

3.5.2 Windows

---

---

3.6

4

4.1 USB

4.2

4.3

5

5.1

5.2

5.3

5.4

---

---

2017

1.0





.

.

.

.

.

.

.

---



.



.

.

.

.

.

.

.





---

# 1

DL-581P/DL-581PW

POS

DL-581P/DL-581PW

USB

WINDOWS

XP/7/8/10/vista Linux

OPOS

1) ,

2)

3)

4)





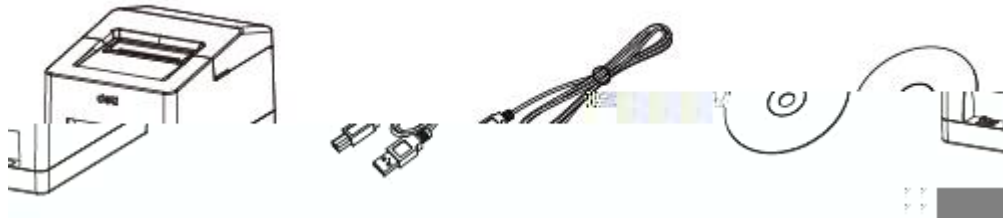

USB

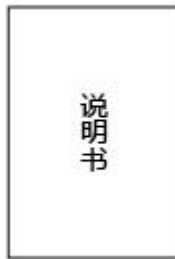

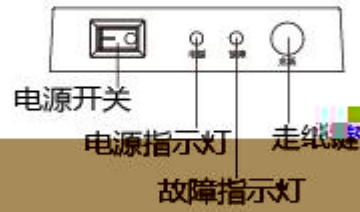

电源开关

操作面板

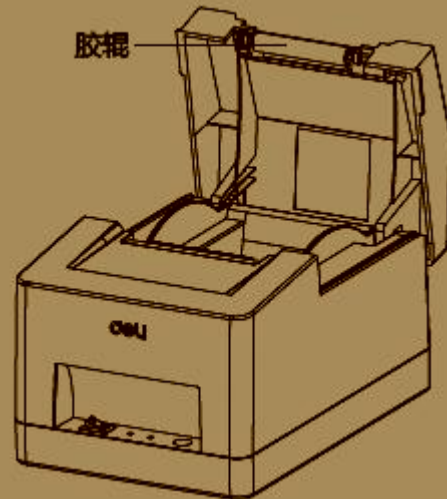
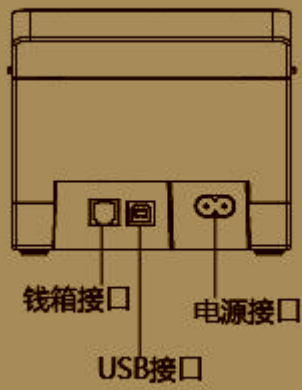

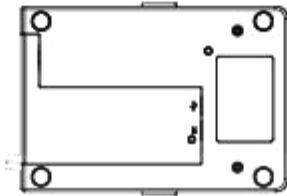
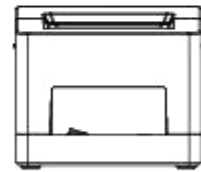
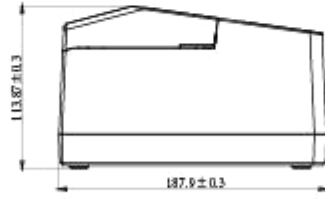
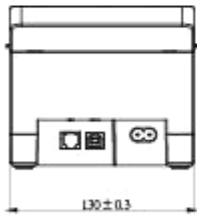
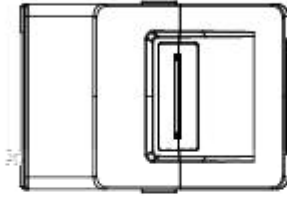
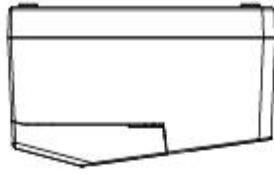

		203 dpi 8 dots/mm
		70mm/s
		48 mm
		1 4
		32-bit RSIC
		2MB
		AC100V-240V
		8V
		58±0.5mm
		0.050 0.090mm
		Max 70mm
		ESC/POS
		Windows XP/Win7/Win8/Win10/Vista/Linux/OPOS
		GBK 16*16 24*24dots
		ASCII 9×17 12×24dots
		PC437/Katakana/PC850/PC860/PC863/PC865/West Europe/ Greek/Hebrew/East Europe/Iran/WPC1252/PC866/PC852/ PC858/IranII/Latvian/Arabic/PT151,1251/PC737/WPC/ 1257/Thai Vietnam/PC864/PC1001/(Latvian)/(PC1001)/ (PT151,1251)/(WPC1257)/(PC864)/(Vietnam)/(Thai)
		( 40K 64K)
		UPC-A, UPC-E, EAN8, EAN13, CODE39, ITF, CODEBAR, CODE128, CODE93
LED		
		5 to 50 25% to 85%RH
		-40 to 60 10% to 90%RH
	( * * )	187.9X113.9X130
		570.5G
	TPH	50km
		CCC

---

1)

2)                                  m m

3)                                  0.050 ~ 0.090mm

4)

FD 210,PD150R,PD160R	OJI Paper CO., LTD.



1)

2)

3)

4)

5)                                  70°C ,

---

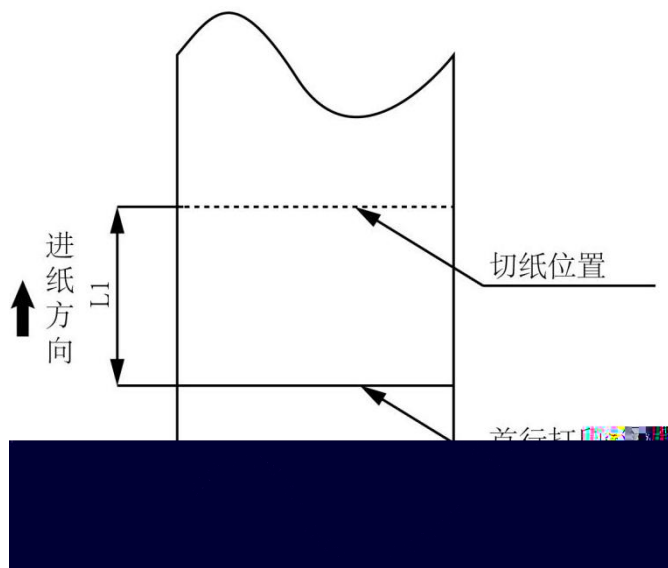
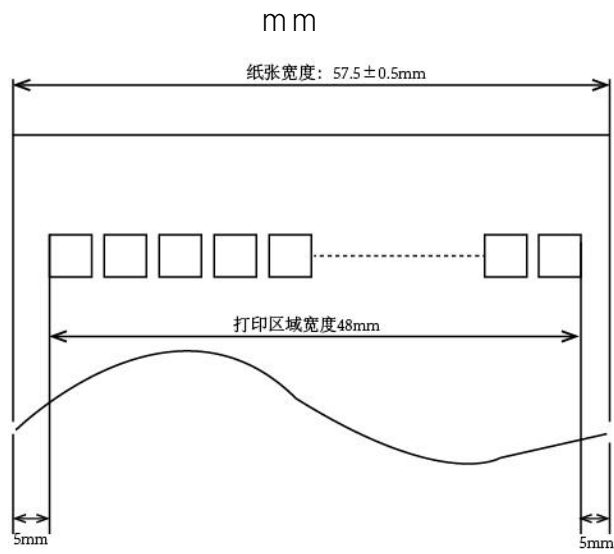

	L1
DL-581P/DL-581PW	7.5mm

# 3

1.

2.

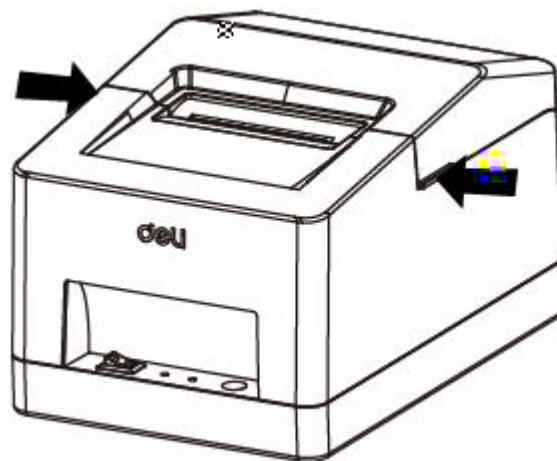

3.

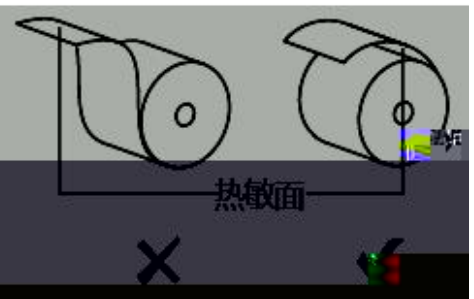
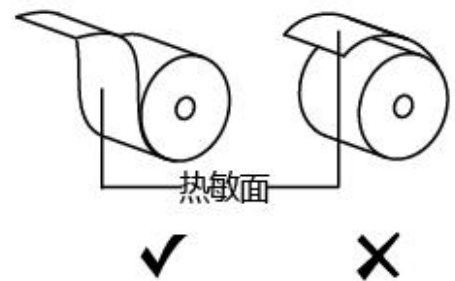
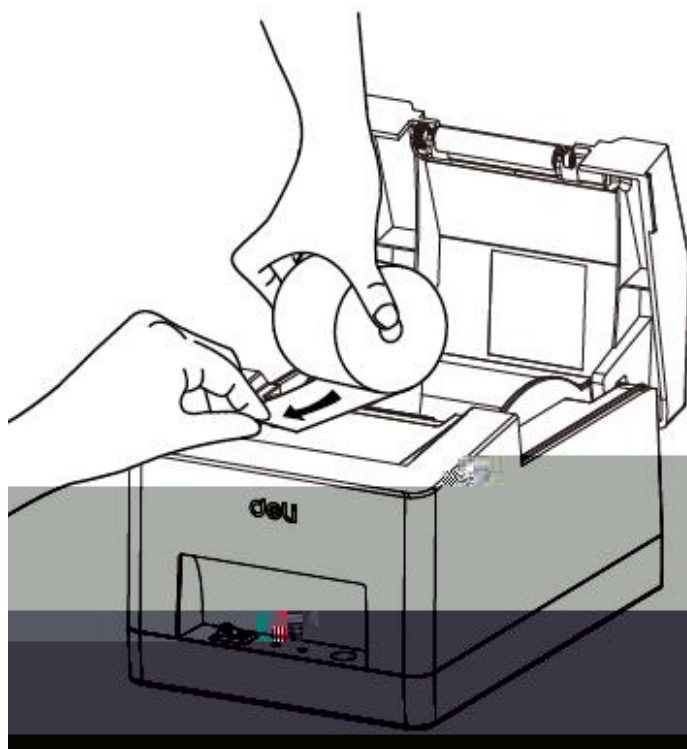

---

4.

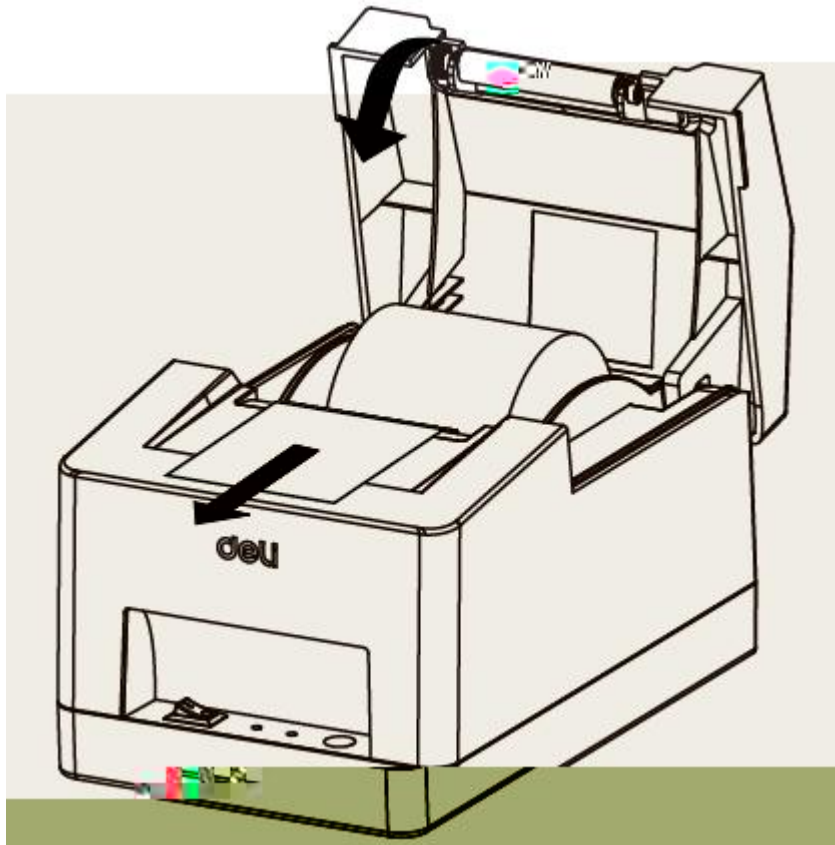

5.

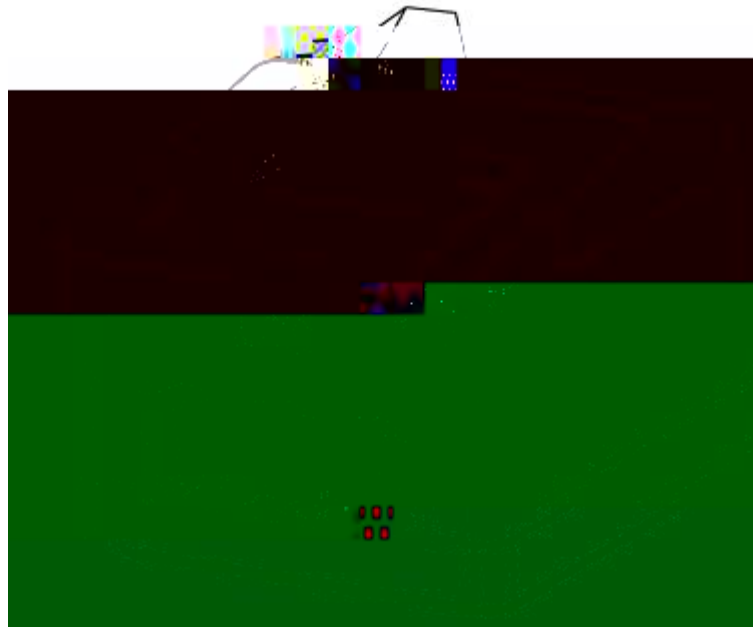



- 1.
- 2.
- 3.

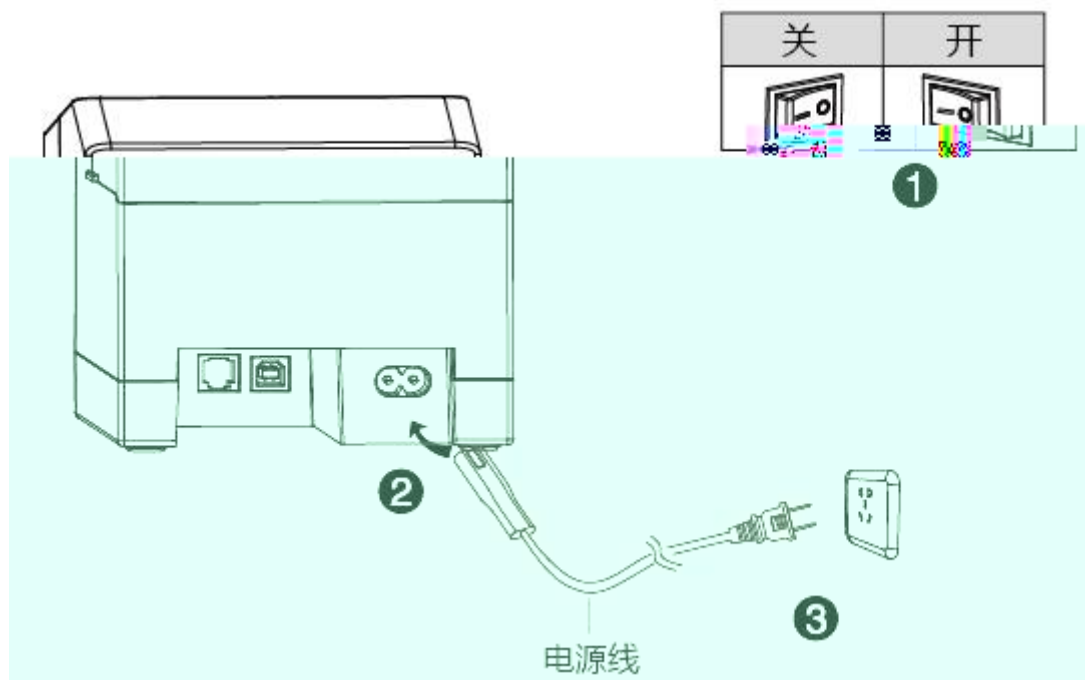





" "

" "



---

1,

2,

3,

4,

( SMARTPHONE ,POCKET PC,PALM,

)



---

DL-581P/DL-581PW

USB

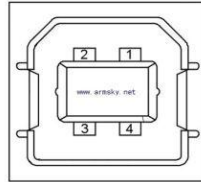

1	VBUS
2	D-
3	D+
4	GND

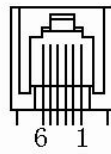

1	FG
2	Drawer 1
3	DRSW
4	VDR
5	Drawer 2
6	GND

" " " "

---

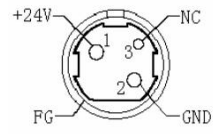

1	+ 24V
2	GND
3	N.C
SHELL	F.G













---



		TPH
		TPH

---



---

**6**

**6.1**

**6.2**

---

