





1 2



:

1

2

2~3

3

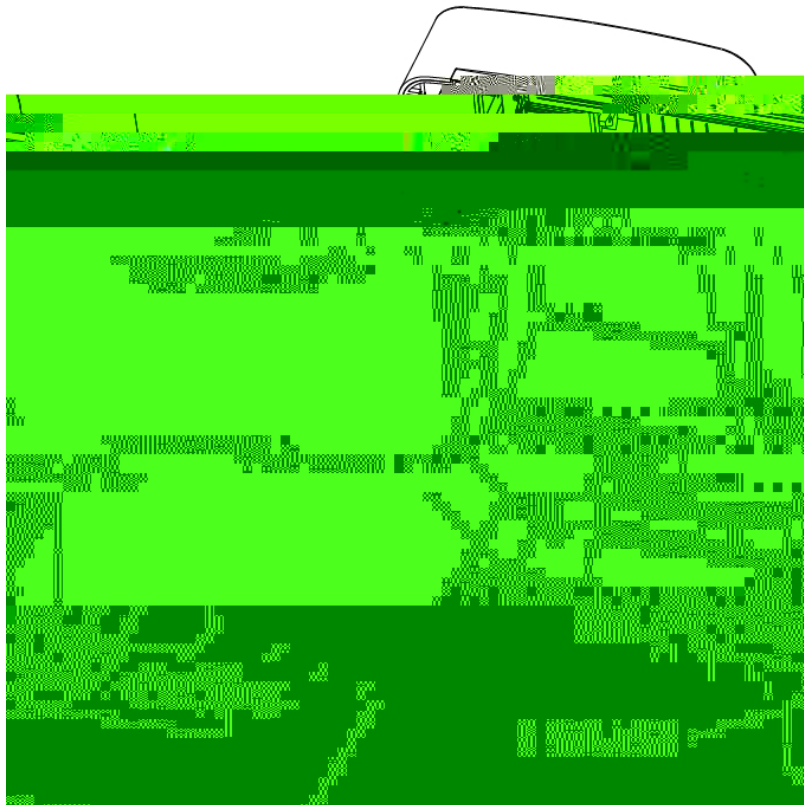
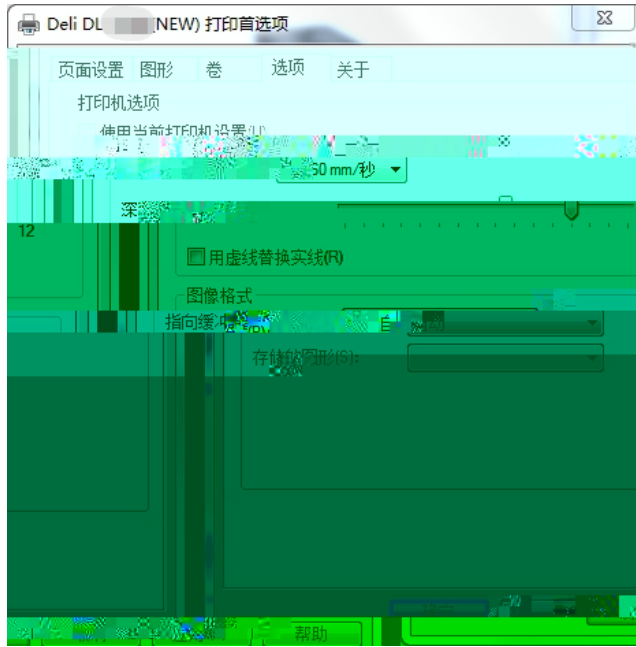



1.



2.









1

•

•

2

•

3

•

4

•

5

•

6

3.



4. WEEE( )







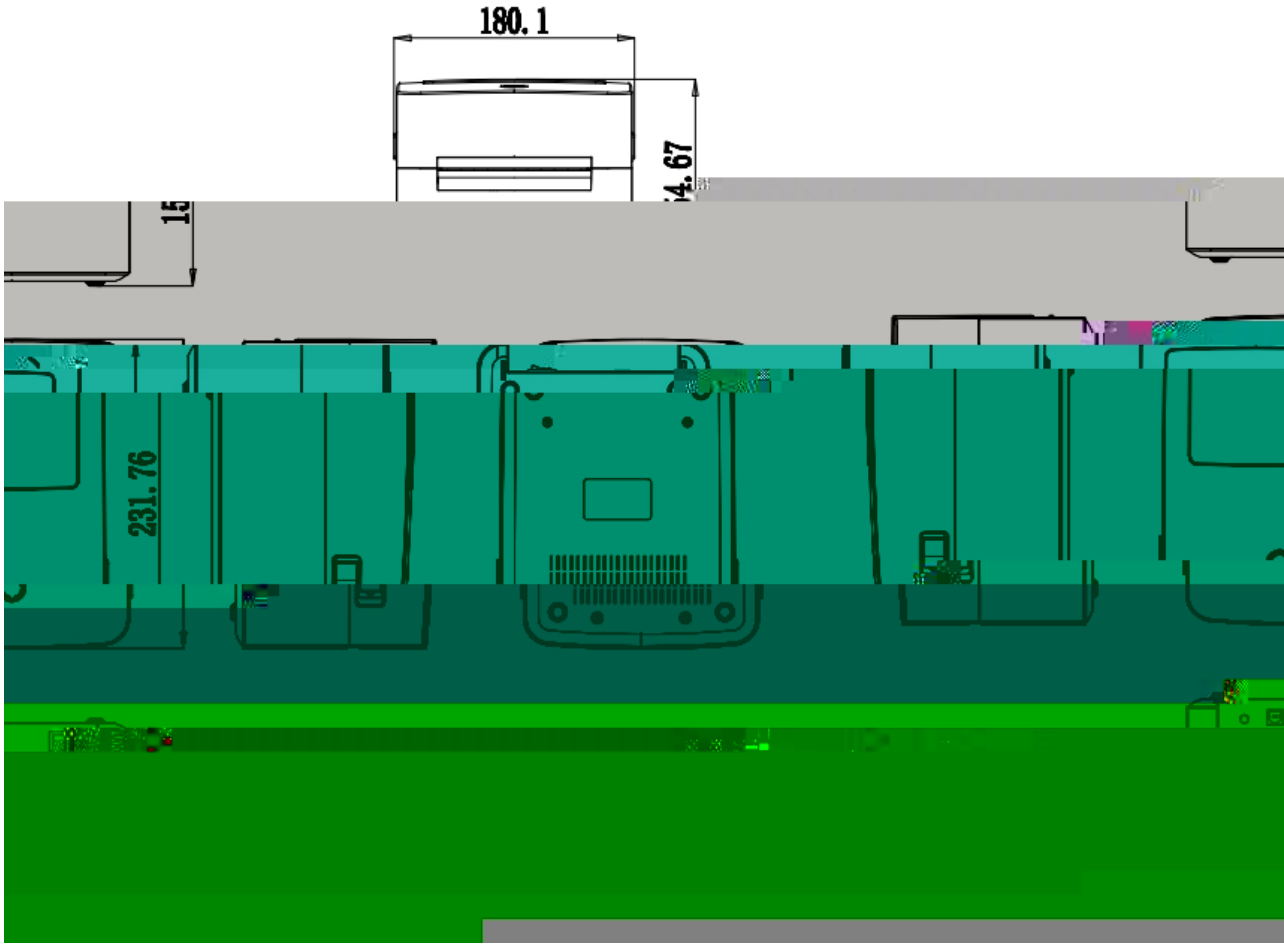





3.1.1

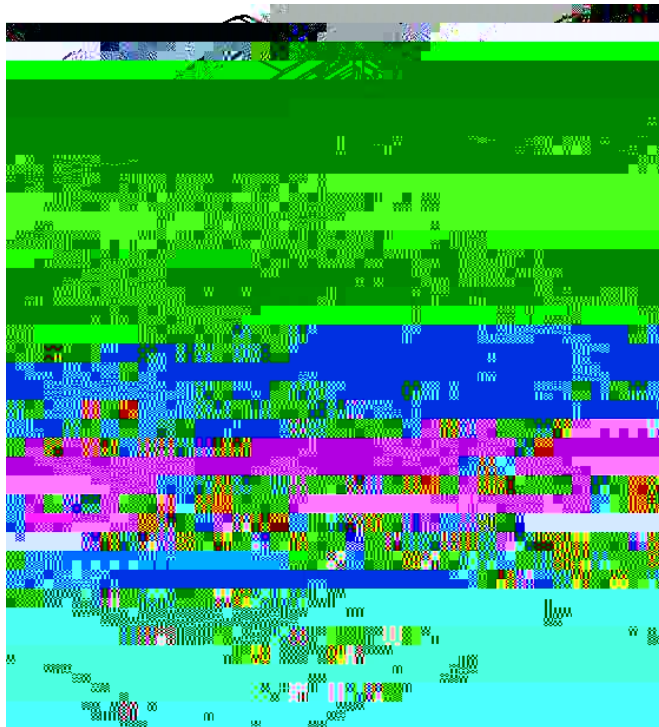
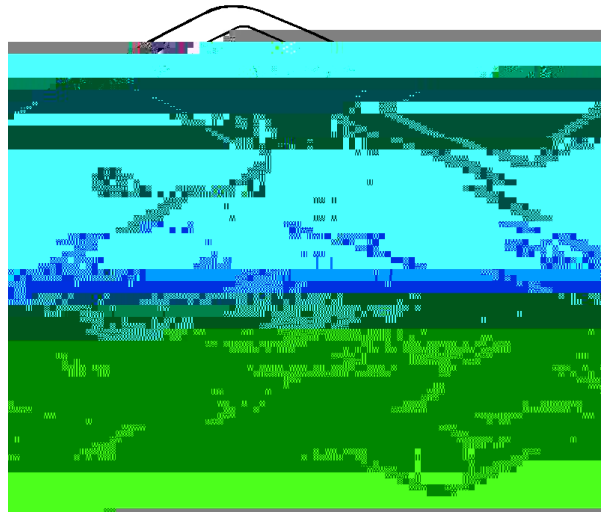



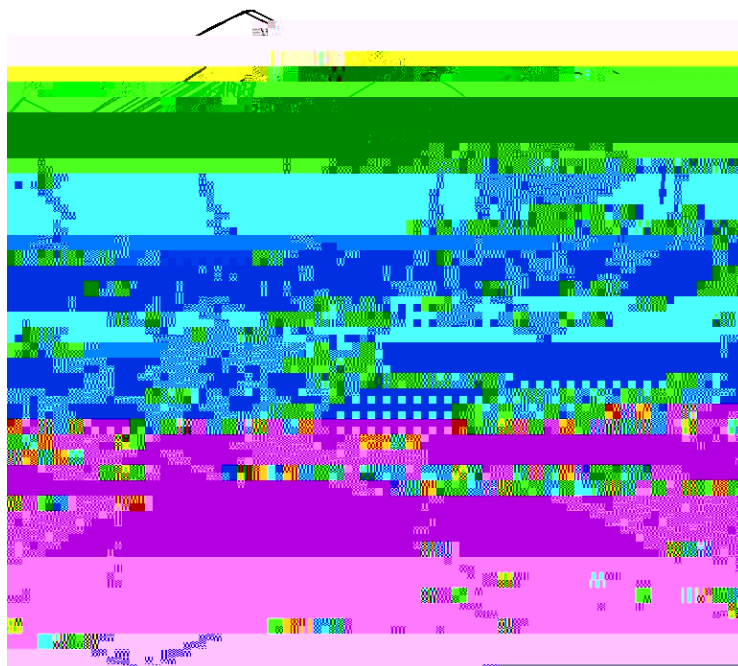

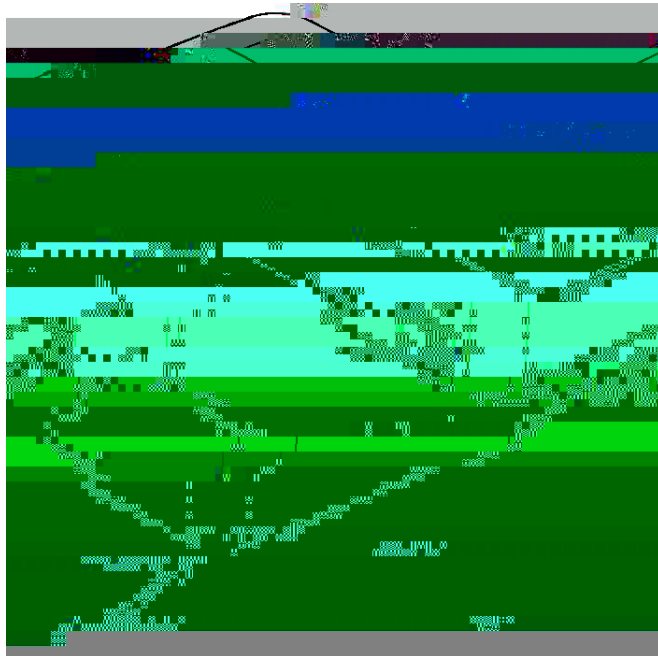

3.1.2

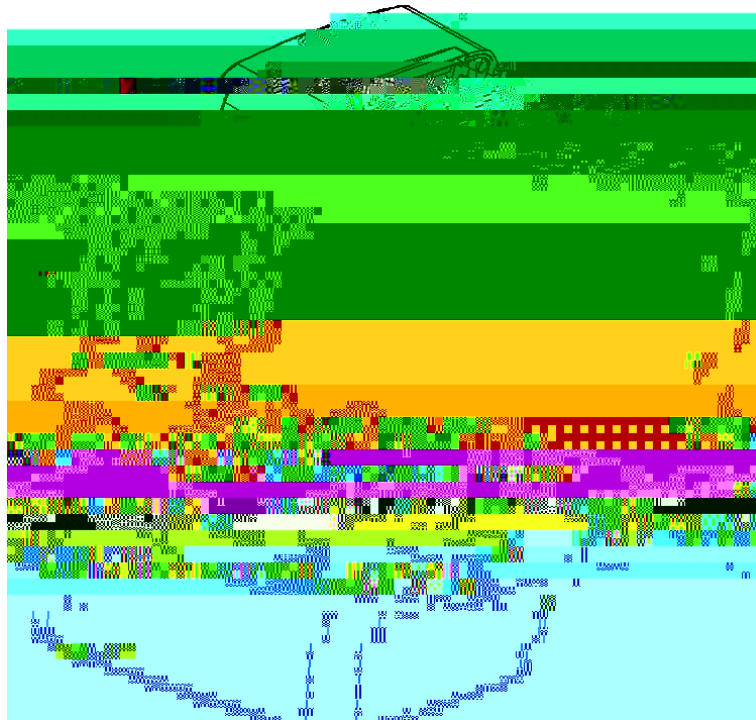
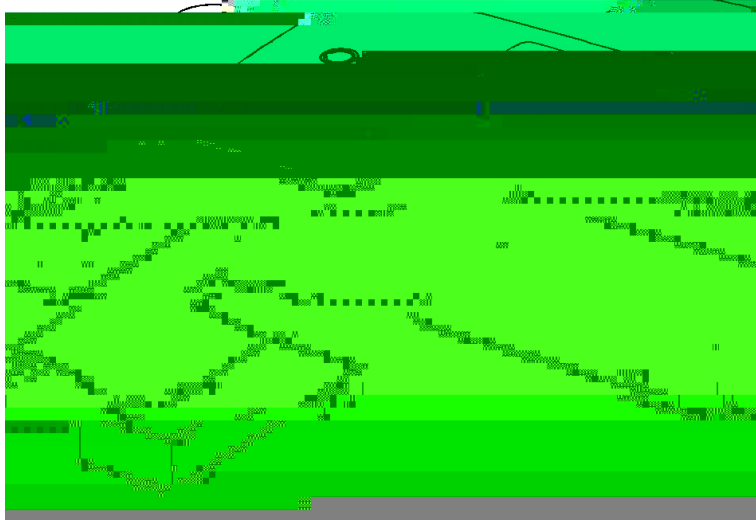

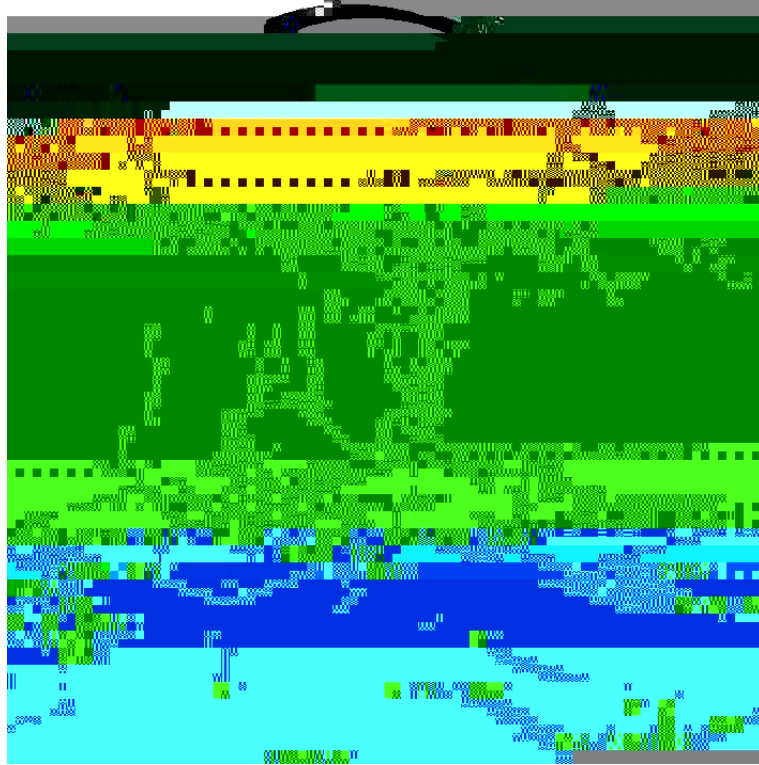

### 3.1.3

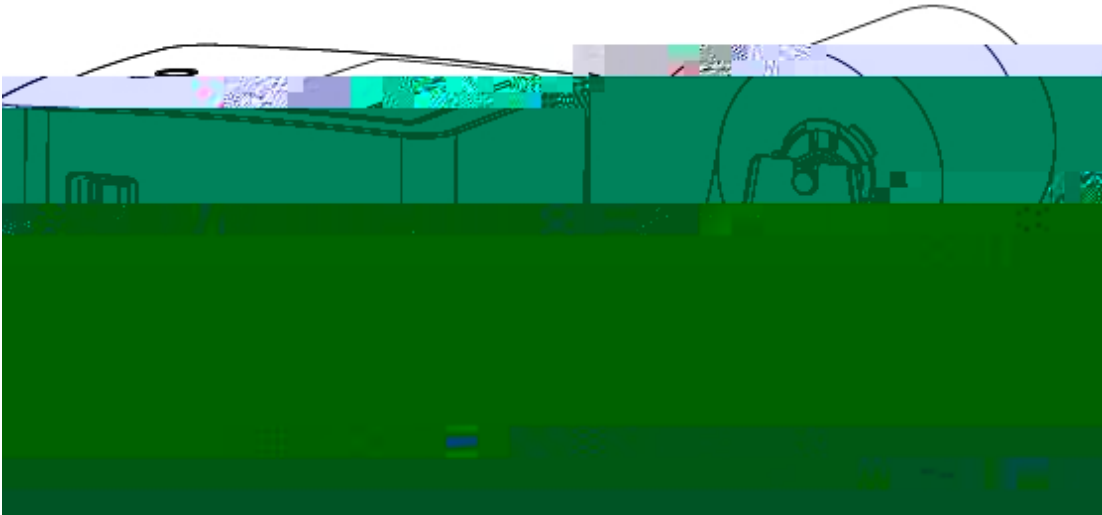

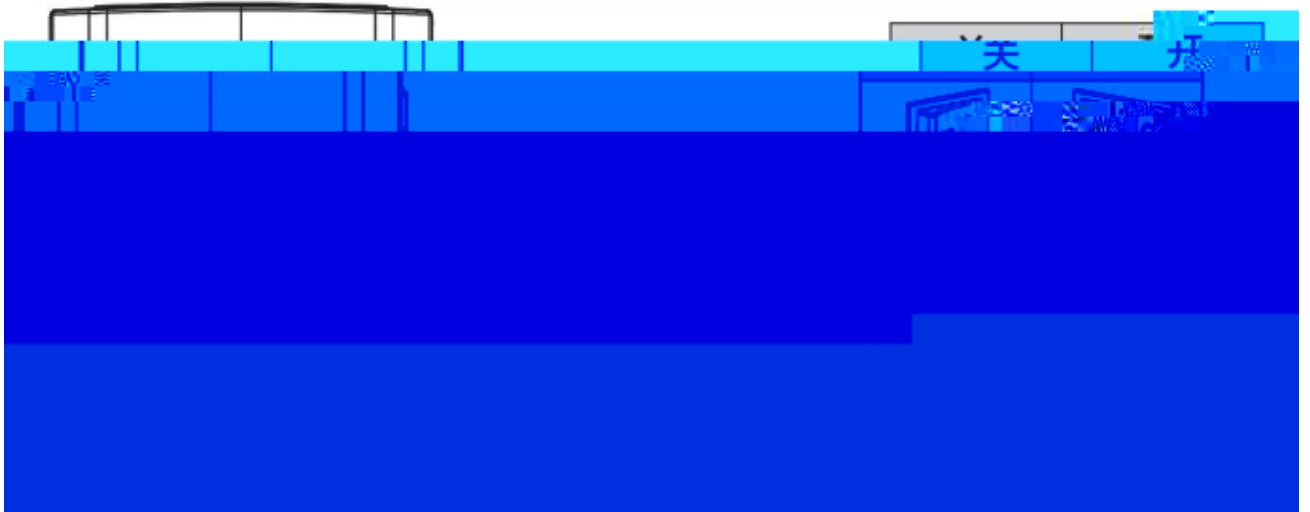

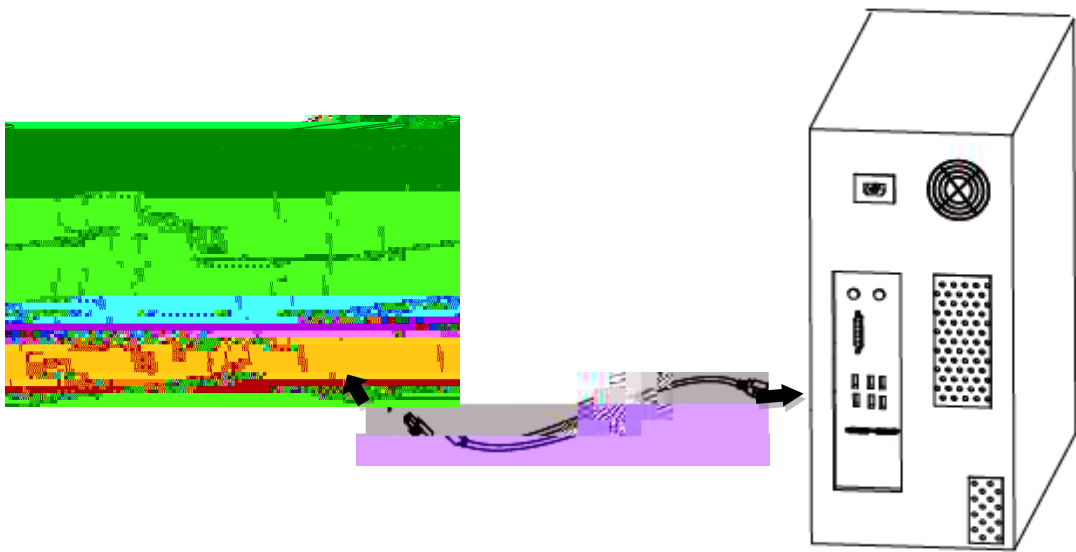

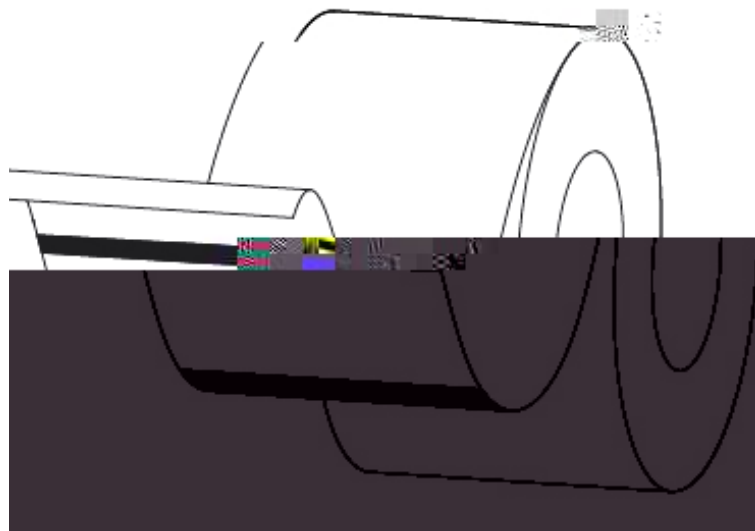
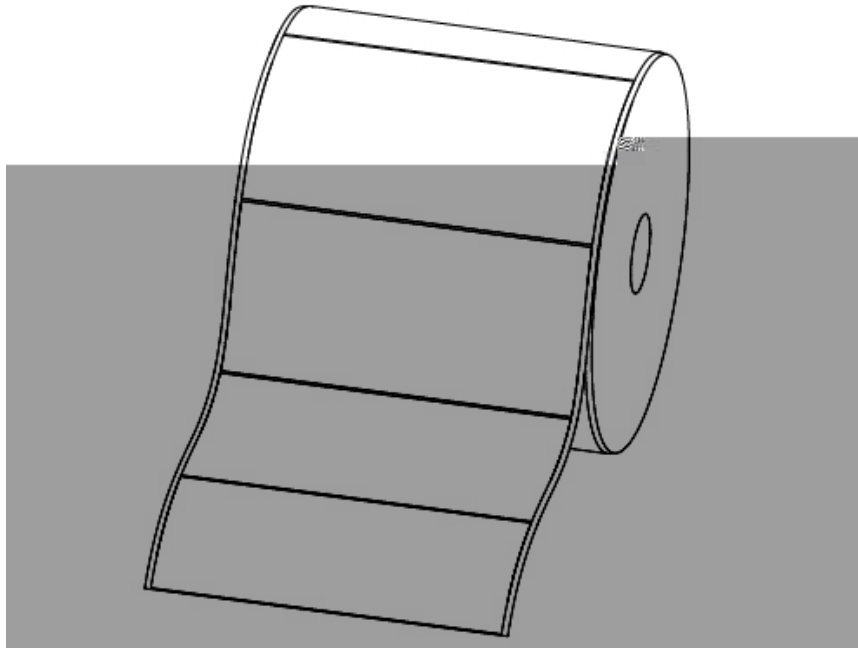











### 3.6.3

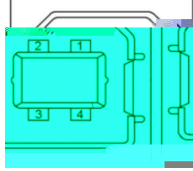

### 3.6.4



1	VBUS
2	D-
3	D+
4	GND

