

GB 18030

台

印

下

在

参 台

5

4

均

台

参

参  
台

下

均

台

!

4. 2. 2

参



---

使用注意事项

参 均

- 
- 
- 
- 
- 
- 
- 
- 
- 
- 
- 
- 
- 
- 
- 

在

各

在

在

在

---

丢

在

220V

各

在

在

在

在

- a.
- b.
- c.
- d.
- e.
- f.
- g.



光盘



联机电线



打印机



色带



电源线



说明书



保修卡

### 7. 配件包

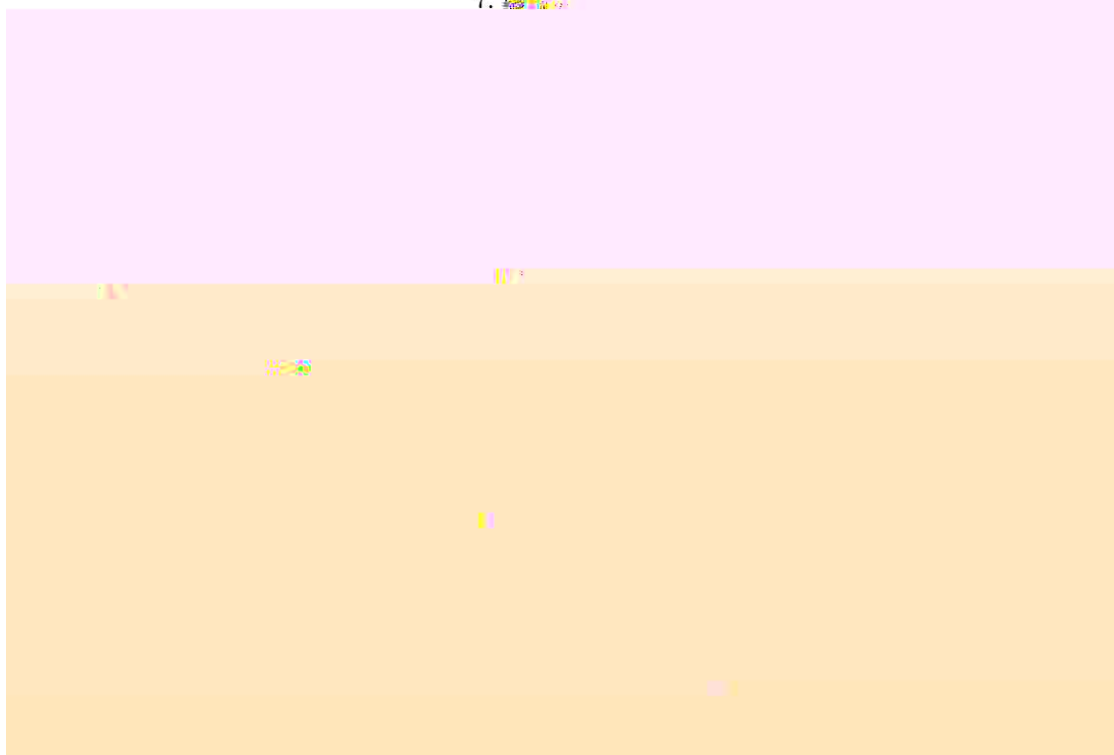

---

参

参

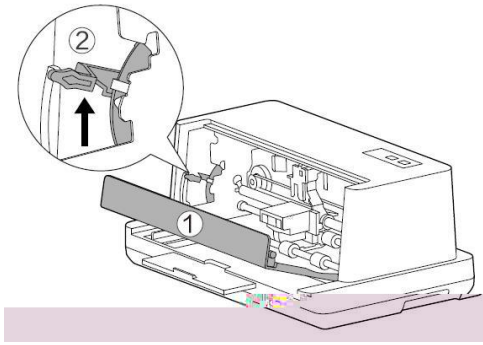

3)

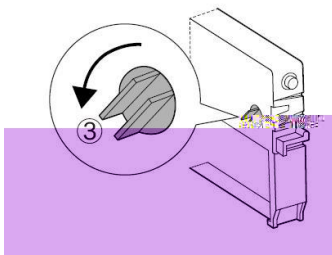

4)

a b c

,

5)

6)

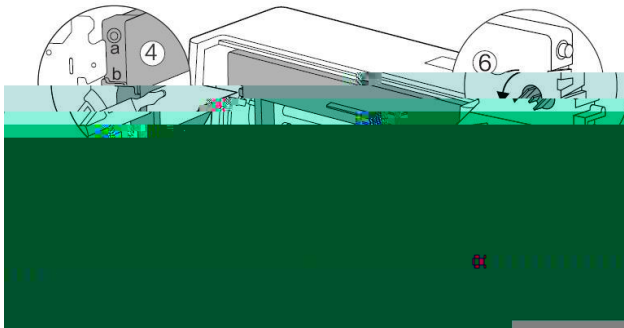

7)

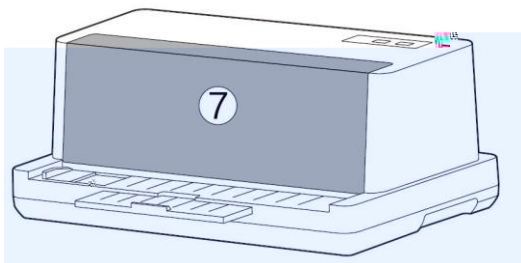



1)

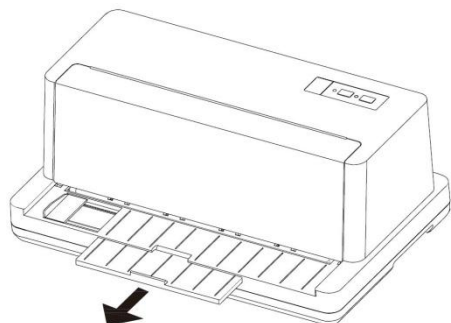

1)

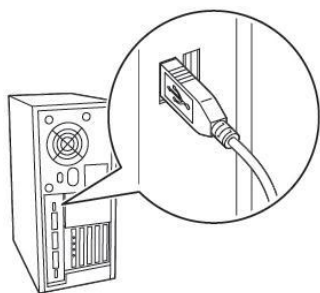

2)

USB



1)

在

2)

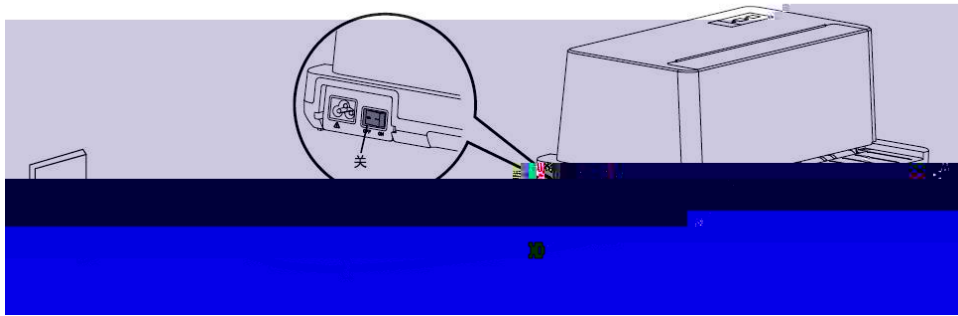

1. 均 5
- 2.

Windows XP / 7 / 8 / 10

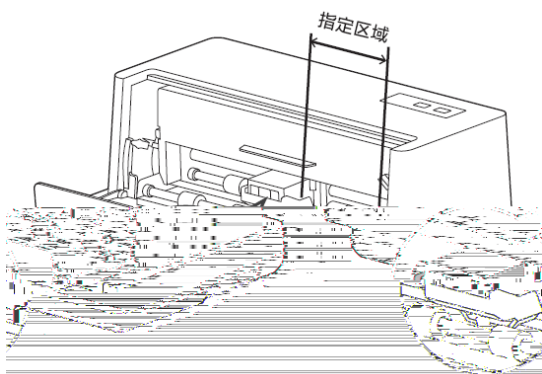

- a. \* U DeliDriver ! Set  
up.exe
- b. 1
- c. 可
- d. USB USB

---

e.

OK

Windows XP/7/8/10

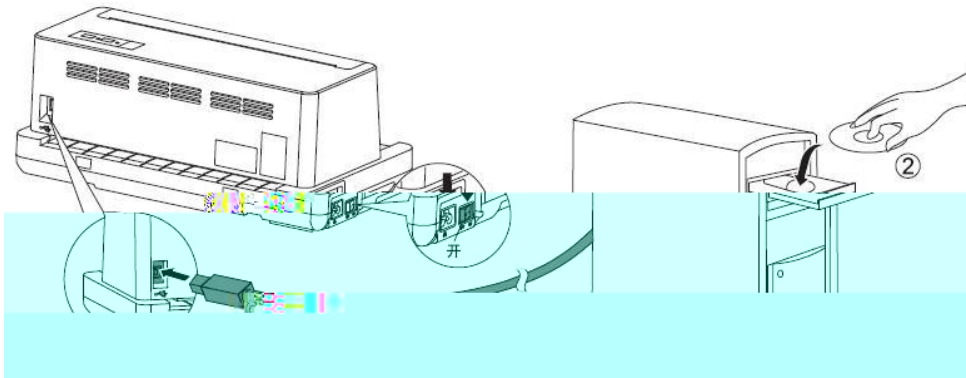

a.

DeliDriver.exe

!

可

参

可

参

- 1)
- 2)

### 2.1.1

	60	-280	/2.4	-11
	58		/2.3	
可	A6		105	*148
	B6 JIS!		128	*182
	A5		148	*210
	B5 JIS!		182	*257
	A4		210	*297
	B4 JIS!		257	*364
	Executive		7.25	*10.5
	Letter		8.5	*11
	LEGAL		8.5	*14
			30-156 元/	
			40-52 元/	
			0.07-0.18	
			0.06-0.7	!

### 2.1.2

- 1)

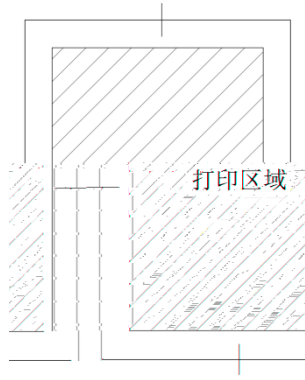

2)

11

8.2

!

1)

叫 ,

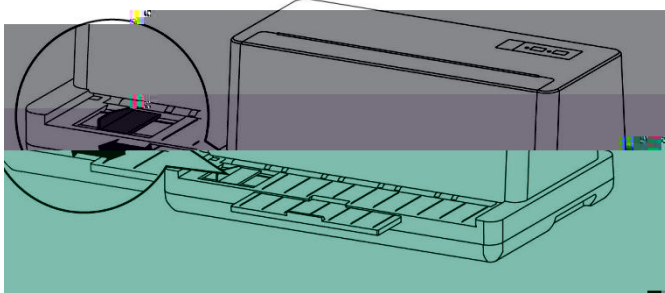

2)

3)

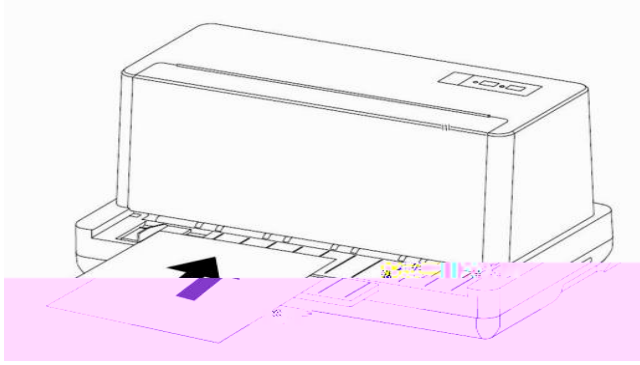

各

业

均

				1 2
!	2	+1	!	2
	3	+2	!	3
	4	+3	!	4
	5	+4	!	5
	6	+5	!	6
				5 6

2 参 2

,

,

3 参 3

,



丢 丢

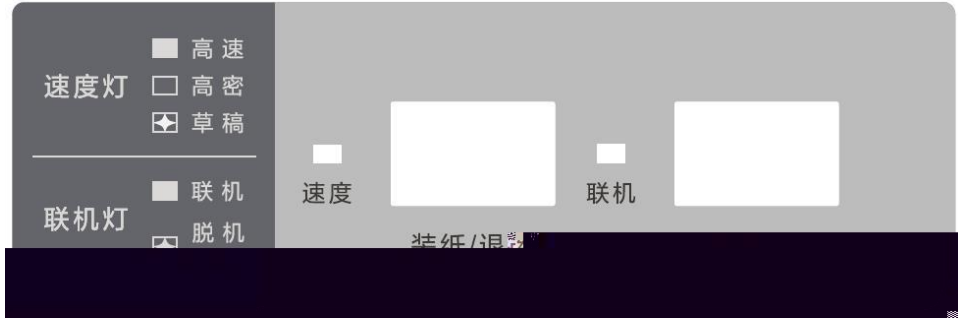

■

( ) ,  
( ) 丢 可

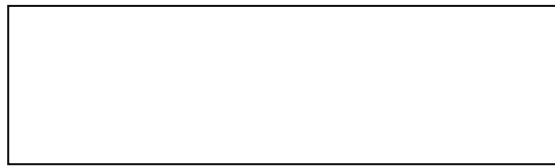

■

/

/

,

/

3

---

### 3.2.1

■

( )

丟 可

■

/

/

### 3.2.2

丟

丟

■



---

### 3.2.3

,

各 各

■

可参 EDS 各

ROM

■ EDS

/ 各

---

!

!

各

!

!

!

!

!



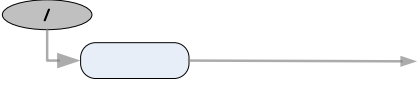

3.

4.

---

### 4.2.1

参 丢 “|” “|” 各

### 4.2.2

	可		

1)

---

2)

!

---

7)

8)

9)

10)

11)

参

### 4.2.3

		A4	2.5      2.75      3      3.5 11/3      4      4.5      5.5 5      6      7      8      11 B5 A4 12      14
		2/12	0      1/12      2/12      3/12 4/12      5/12      6/12 7/12      8/12      9/12 10/12      11/12      12/12 13/12

---

1)

各

2.5      2.75      3      3.5      11/3      4      4.5  
5.5      5      6      7      8      11      B5 A4 12  
14

2)

0      1/12      2/12      3/12      4/12      5/12  
6/12      7/12      8/12      9/12      10/12      11/12  
12/12      13/12

3)

4)

5)

6)

#### 4.2.4

---

参

口

5.2

		2 参 2 ,
		3 参 3 ,
	入	
		/ /

台 丢 丢  
,



---

	各 参

---

	均

均	

各	均

?	
各	在

---

3!

	0.7mm



均



均



参



# 1

## 产品中有害物质的名称及含量

部件名称	有害物质					
	铅(Pb)	汞(Hg)	镉(Cd)	六价铬(Cr(VI))	多溴联苯(PBB)	多溴二苯醚(PBDE)
电线						
印刷电路板						
塑胶						
轴、金属轴						
其他金属						

规定限量要求以下。

表示该有害物质在该部件所有均质材料中的含量均在GB/T26578规定的限量要求以下。