

---

**0/**  
**/**

**0-**  
**-**

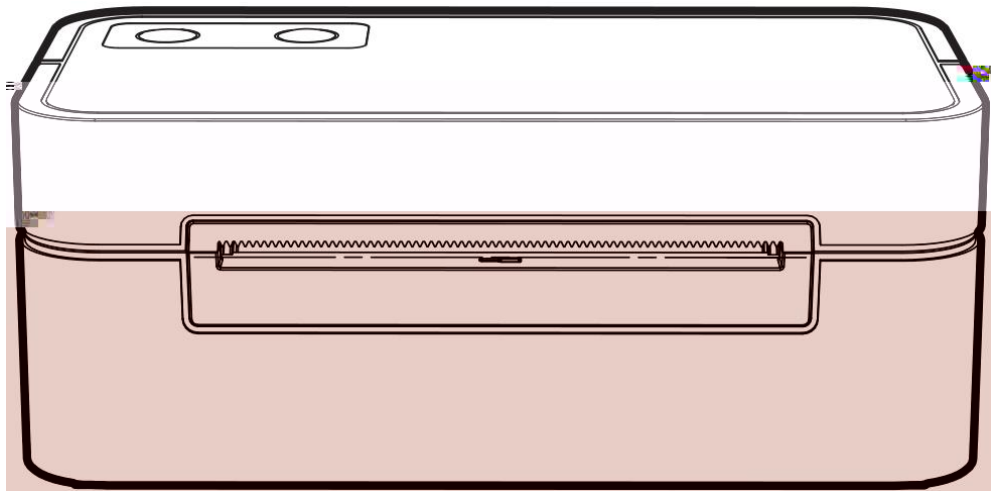





1.



2.







1

•

•

2

•

3

•

4

•

5

•

6

3.



4. WEEE( )







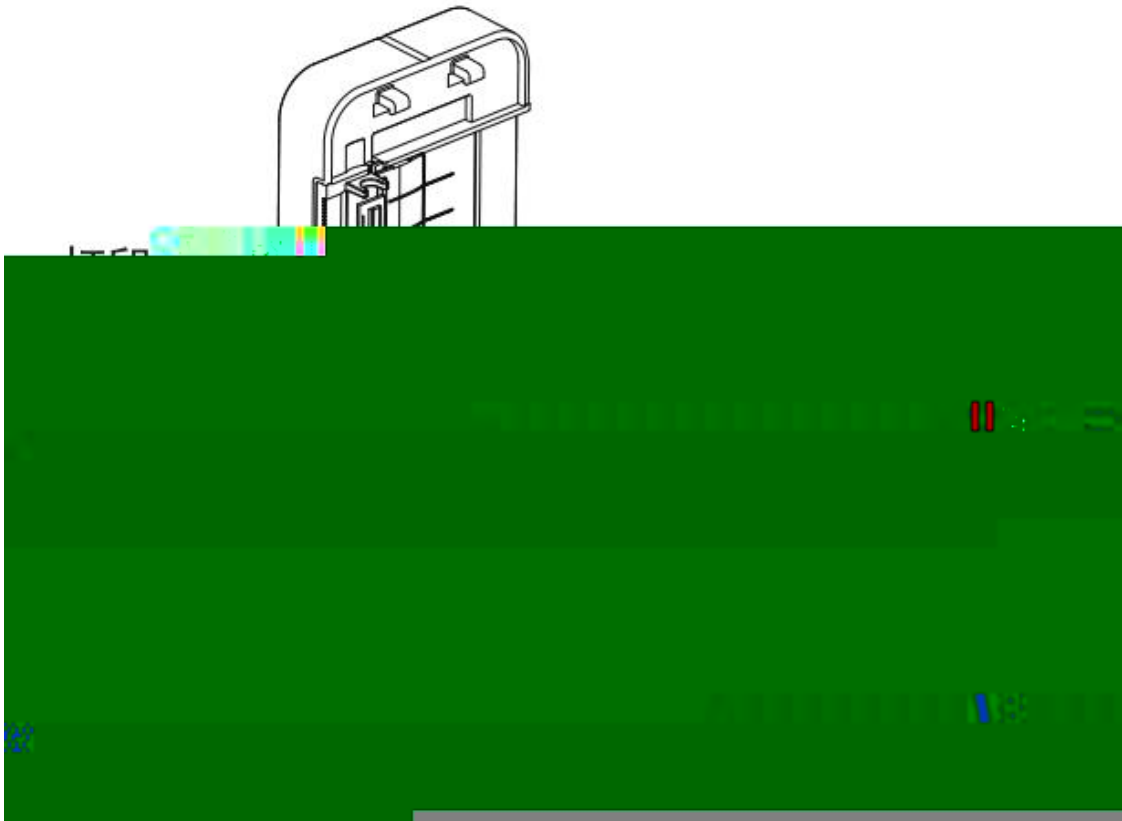
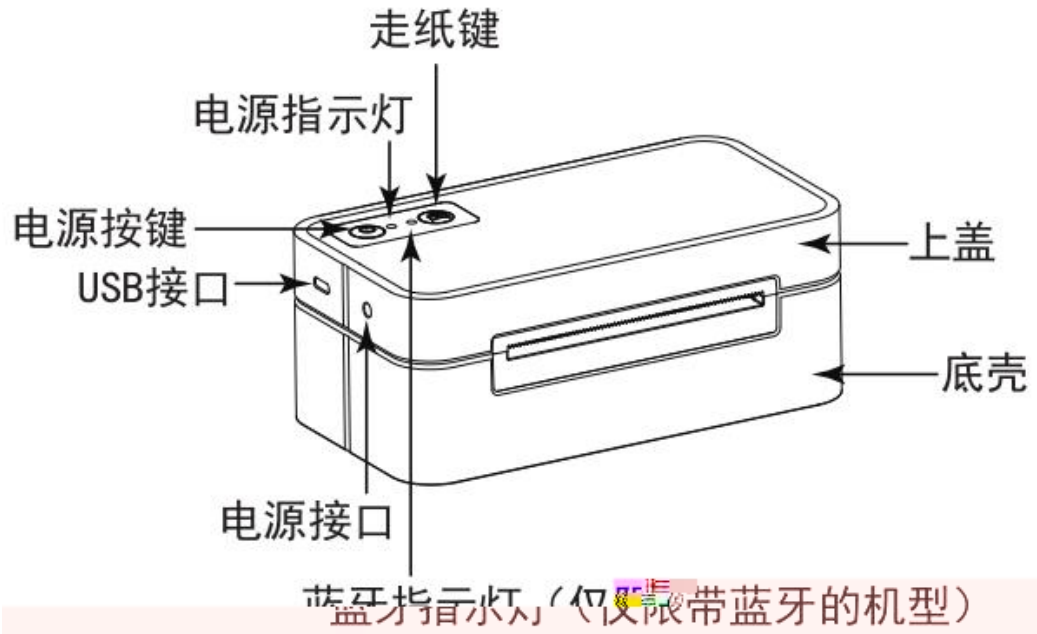

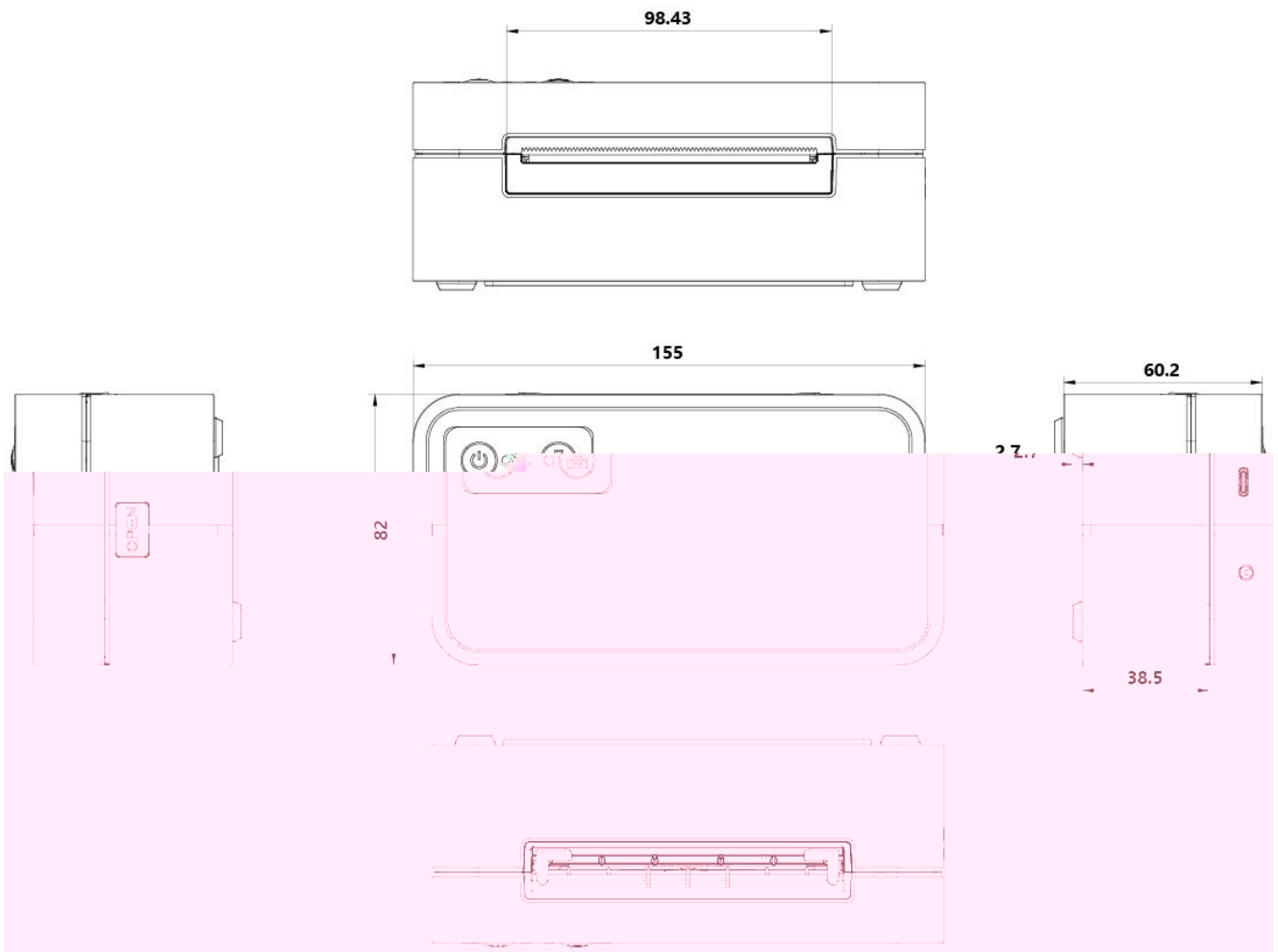



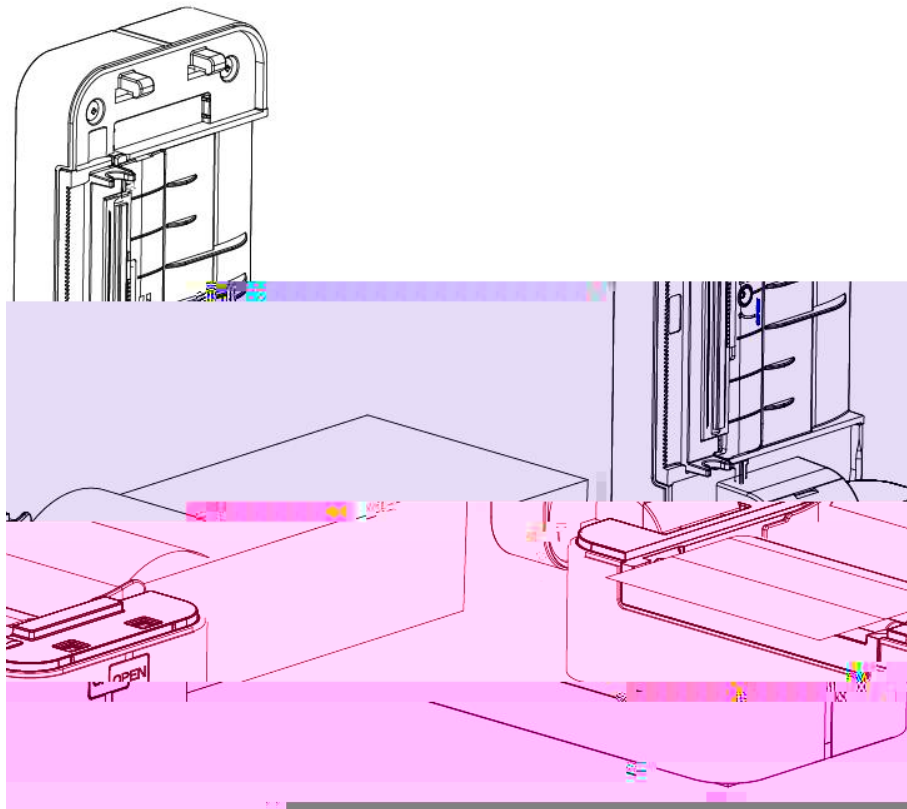
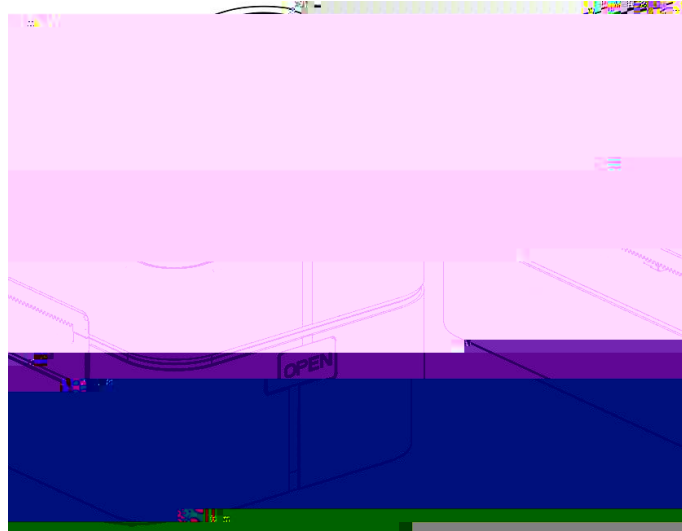

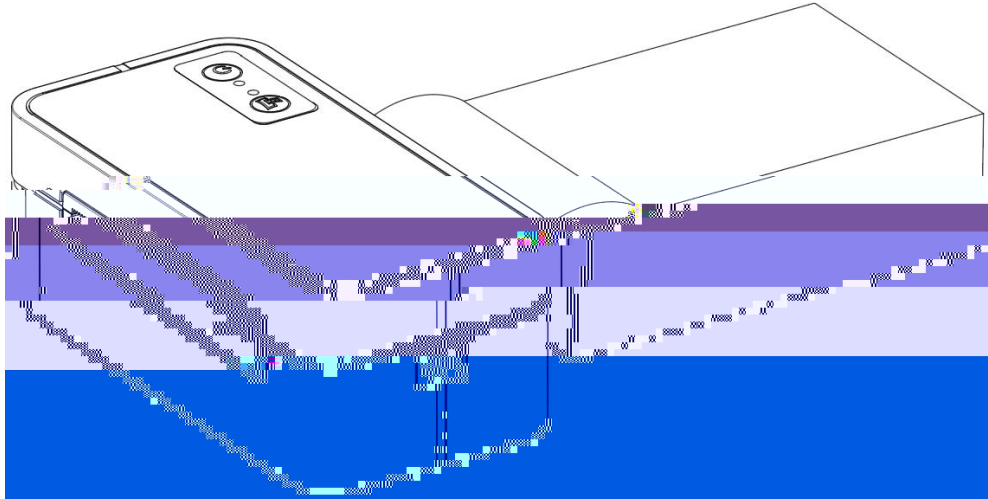

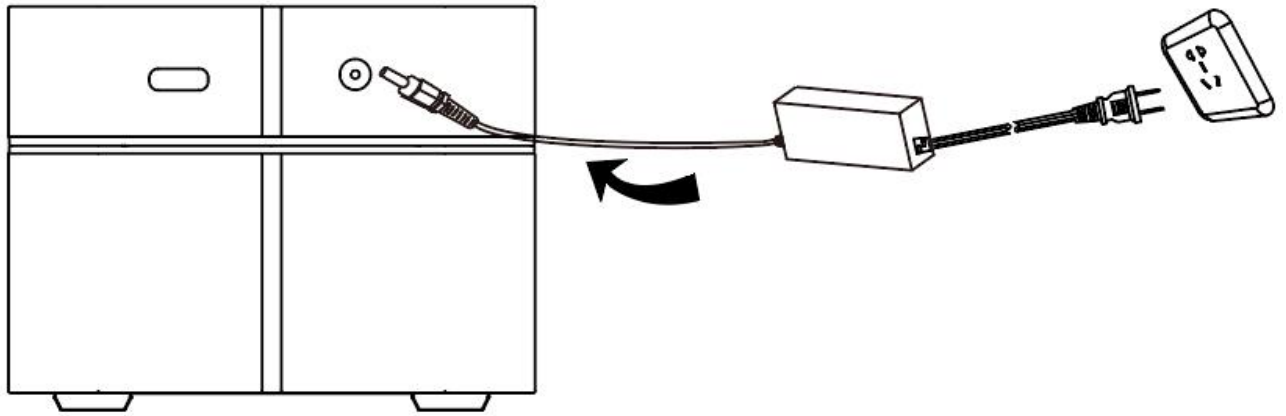

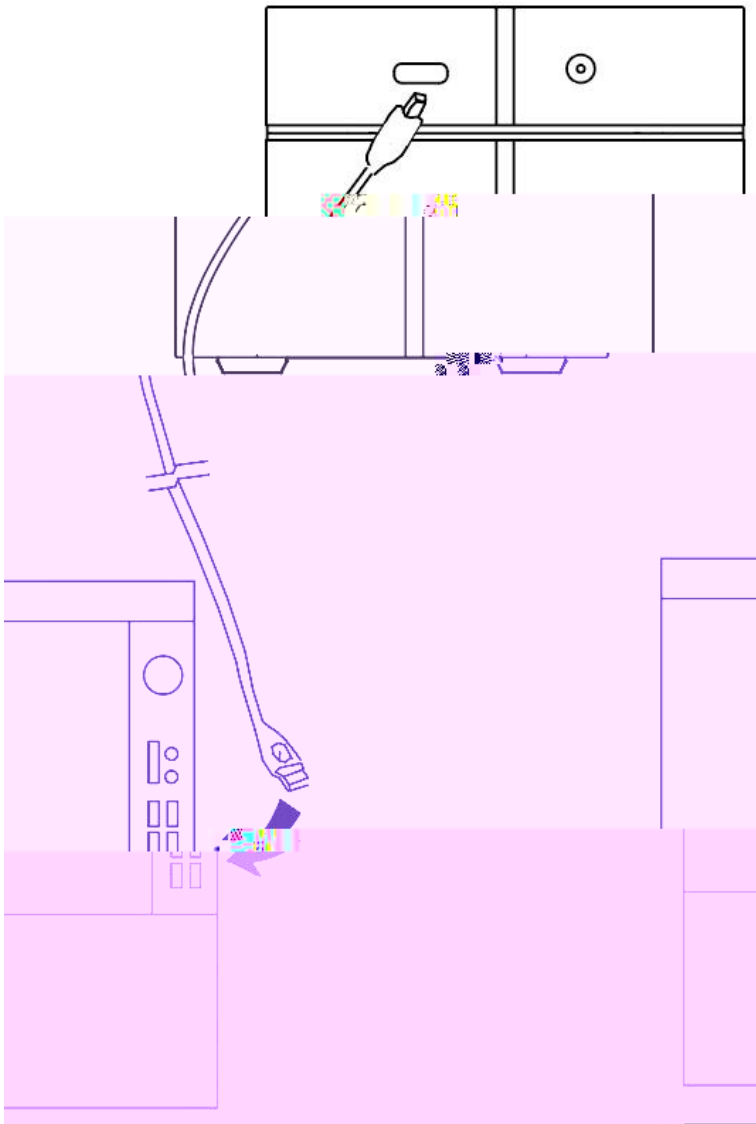



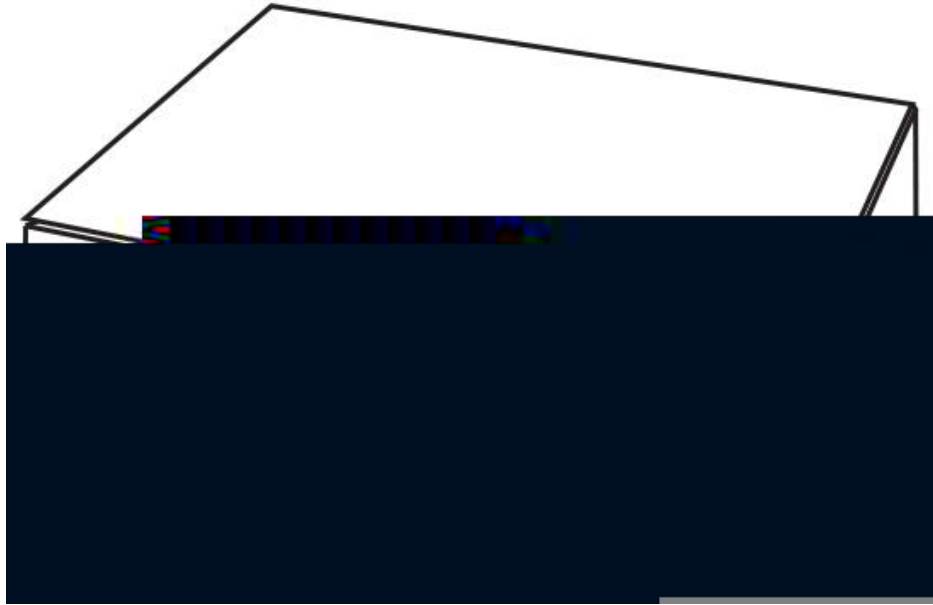



### 3.6.1 /



### 3.6.2

### 3.6.3

.

.



### 3.6.4

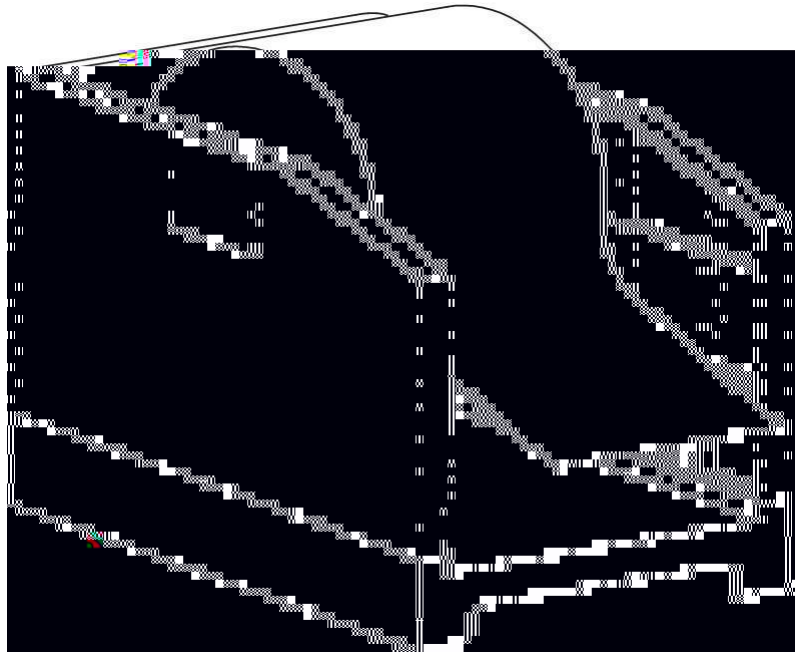

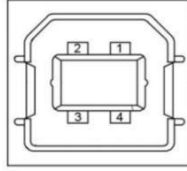

1	VBUS
2	D-
3	D+
4	GND

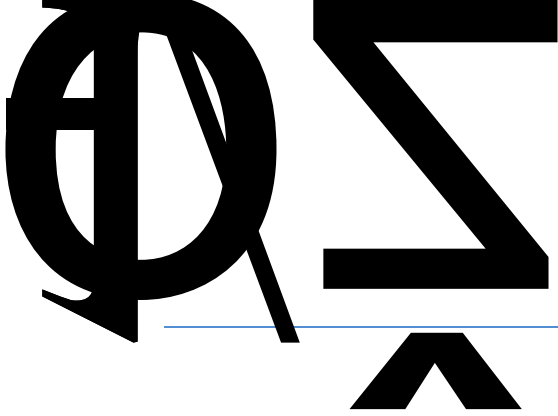

:



1

2

3

4

1 2

